



## PUBLIC ADDRESS SYSTEM

# OPERATION MANUAL

TI-120S  
TI-240S  
TI-350S  
MIXER ZONE AMPLIFIER



Please follow the instructions in this manual to obtain the optimum results from this unit. We also recommend that you keep this manual handy for future reference.

# TABLE OF CONTENTS

<b>1. SAFETY PRECAUTIONS</b> .....	3
<b>2. GENERAL DESCRIPTION</b> .....	5
<b>3. FEATURES</b> .....	5
<b>4. NOMENCLATURE AND FUNCTIONS</b>	
4.1 Front Panel .....	6
4.2 Rear Panel.....	8
<b>5. OPERATING</b> .....	9
<b>6. APPLICATIONS</b> .....	10
<b>7. SPECIFICATIONS</b> .....	11
<b>8. BLOCK DIAGRAM</b> .....	12
<b>9. DIMENSIONAL DIAGRAM</b> .....	13

# 1. SAFETY PRECAUTIONS

- Be sure to read the instructions in this section carefully before use.
- Make sure to observe the instructions in this manual as the conventions of safety symbols and messages regarded as very important precautions are included.
- We also recommend you keep this instruction manual handy for future reference.

## Safety Symbol and Message Conventions

Safety symbols and messages described below are used in this manual to prevent bodily injury and property damage which could result from mishandling. Before operating your product, read this manual first and understand the safety symbols and messages so you are thoroughly aware of the potential safety



### WARNING

Indicates a potentially hazardous situation which, if mishandled, could result in death or serious personal injury.



### CAUTION

Indicates a potentially hazardous situation which, if mishandled, could result in moderate or minor personal injury, and/or property damage.



### WARNING

#### When Installing the Unit

- Do not expose the unit to rain or an environment where it may be splashed by water or other liquids, as doing so may result in fire or electric shock.
- Use the unit only with the voltage specified on the unit. Using a voltage higher than that which is specified may result in fire or electric shock.
- Do not cut, kink, otherwise damage nor modify the power supply cord. In addition, avoid using the power cord in close proximity to heaters, and never place heavy objects -- including the unit itself -- on the power cord, as doing so may result in fire or electric shock.
- Be sure to replace the unit's terminal cover after connection completion. Because high voltage is applied to the speaker terminals, never touch these terminals to avoid electric shock.
- Be sure to ground to the safety ground (earth) terminal to avoid electric shock. Never ground to a gas pipe as a catastrophic disaster may result.
- Avoid installing or mounting the unit in unstable locations, such as on a rickety table or a slanted surface. Doing so may result in the unit falling down, causing personal injury and/or property damage.

#### When the Unit is in Use

- Should the following irregularity be found during use, immediately switch off the power, disconnect the power supply plug from the AC outlet and contact your nearest **ITC** dealer. Make no further attempt to operate the unit in this condition as this may cause fire or electric shock.
  - If you detect smoke or a strange smell coming from the unit.
  - If water or any metallic object gets into the unit
  - If the unit falls, or the unit case breaks
  - If the power supply cord is damaged (exposure of the core, disconnection, etc.)
  - If it is malfunctioning (no tone sounds.)
- To prevent a fire or electric shock, never open nor remove the unit case as there are high voltage components inside the unit. Refer all servicing to your nearest **ITC** dealer.
- Do not place cups, bowls, or other containers of liquid or metallic objects on top of the unit. If they accidentally spill into the unit, this may cause a fire or electric shock.
- Do not insert nor drop metallic objects or flammable materials in the ventilation slots of the unit's cover, as this may result in fire or electric shock.

# 1. SAFETY PRECAUTIONS

## CAUTION

### When Installing the Unit

- Never plug in nor remove the power supply plug with wet hands, as doing so may cause electric shock.
- When unplugging the power supply cord, be sure to grasp the power supply plug; never pull on the cord itself. Operating the unit with a damaged power supply cord may cause a fire or electric shock.
- When moving the unit, be sure to remove its power supply cord from the wall outlet. Moving the unit with the power cord connected to the outlet may cause damage to the power cord, resulting in fire or electric shock. When removing the power cord, be sure to hold its plug to pull.
- Do not block the ventilation slots in the unit's cover. Doing so may cause heat to build up inside the unit and result in fire.
- Avoid installing the unit in humid or dusty locations, in locations exposed to the direct sunlight, near the heaters, or in locations generating sooty smoke or steam as doing otherwise may result in fire or electric shock.

### When the Unit is in Use

- Do not place heavy objects on the unit as this may cause it to fall or break which may result in personal injury and/or property damage. In addition, the object itself may fall off and cause injury and/or damage.
- Make sure that the volume control is set to minimum position before power is switched on. Loud noise produced at high volume when power is switched on can impair hearing.
- Do not operate the unit for an extended period of time with the sound distorting. This is an indication of a malfunction, which in turn can cause heat to generate and result in a fire.
- Contact your **ITC** dealer as to the cleaning. If dust is allowed to accumulate in the unit over a long period of time, a fire or damage to the unit may result.
- If dust accumulates on the power supply plug or in the wall AC outlet, a fire may result. Clean it periodically. In addition, insert the plug in the wall outlet securely.
- Switch off the power, and unplug the power supply plug from the AC outlet for safety purposes when cleaning or leaving the unit unused for 10 days or more. Doing otherwise may cause a fire or electric shock.

An all-pole mains switch with a contact separation of at least 3 mm in each pole shall be incorporated in the electrical installation of the building.

## 2. GENERAL DESCRIPTION

The Mixer Zone Amplifier series is equipped with priority function. They are designed to suit all PA system application in schools 、 home 、 offices and stores.

## 3. FEATURES

- 5 zone output and 5 zone separate volume control.
- Built-in siren.
- Built-in 24v interface.
- Each channel with separate treble and bass control.
- Built-in 24V phantom power and separate power switch.
- Capacity of controlling by remote paging MIC.
- Selectable priority muting
  - Switchable audio signal priority for MIC channels 1
  - 1 EMC input signal over other input sources.
  - 2 Remote MIC and Telephone input over SIREN、 CHIME、 MIC 1~4 、 LINE 1~2、 input sources
  - 3 MIC 1、 SIREN、 CHIME over MIC 2~3、 LINE 1~2 input sources

## 4. NOMENCLATURE AND FUNCTIONS

### 4.1 FRONT PANEL

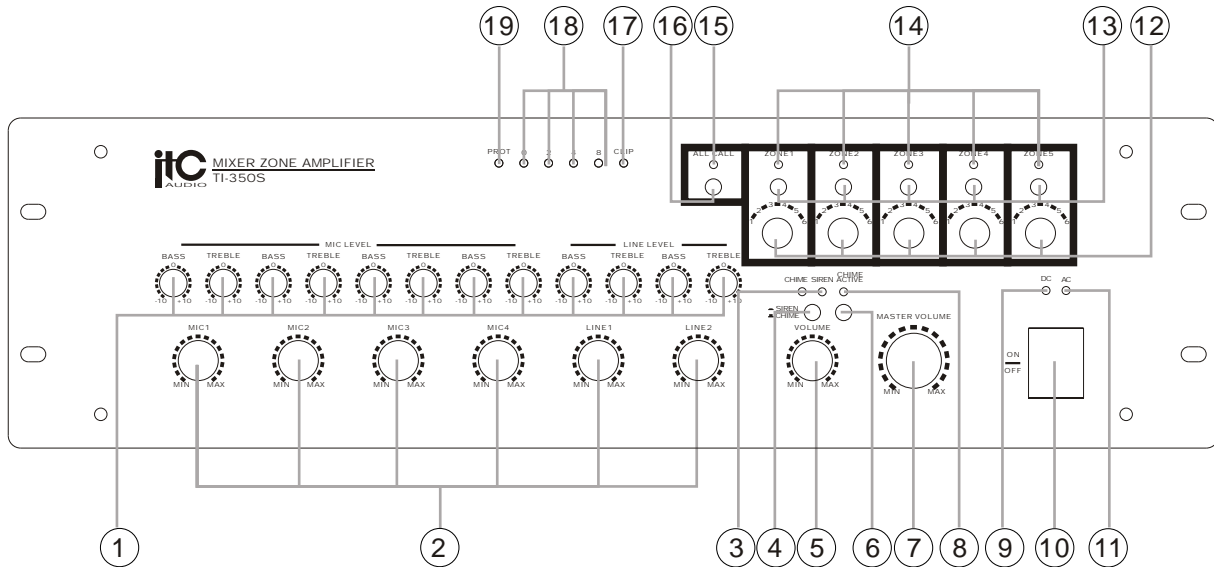

#### 1. TONE CONTROL

Individual Bass and Treble controls are used to cut (decrease) or boost (increase) the lower and Higher frequencies  $\pm 12\text{dB}$ .

#### 2. CHANNEL VOLUME

Controls the individual volume levels of Channels.

#### 3. CHIME INDICATOR AND SIREN/INDICATOR

#### 4. SELECT KEY

##### ● CHIME

When the key out, select chime state, chime indicator LED on, activate chime signal and selection zone output.

##### ● SIREN

When key in, the siren is acticated, all the zone will be open and siren signal output.

#### 5. CHIME AND SIREN VOLUME

#### 6. INTERNAL CHIME ACTIVE

#### 7. MASTER VOLUME

This rotary switch controls the overall output volume of the amplifiers output signal.

#### 8. CHIME ACTIVE INDICATOR

#### 9. DC INDICATOR

24V DC supply power the indicator on

#### 10. POWER SWITCH

Pressing this switch turns the unit on, as indicated by the Power LED above the switch. Pressing it again turns the unit off.

#### 1.AC INDICATOR

$\sim 220\text{V}$  AC supply power the indicator on

#### 12.SPEAKER SELECTOR

These switches are used to select output to any combination of up to five individual speakers.

OUTPUT VOLTAGE	120W	MIN	2
	240W	6V	12.5V
	350W	6V	12.5V
3	4	5	MAX
22V	50V	70V	100V
32V	50V	70V	100V
38V	50V	70V	100V

#### 13.(ZONE1~ZONE5)ZONE SELECTION BUTTON

#### 14.(ZONE1~ZONE5)ZONE SELECTION INDICATOR

#### 15.ALL CALL INDICATOR

#### 16.ALL CALL CONTROL

#### 17.CLUP INDICATOR LED

#### 18.OUTPUT LEVEL INDICATOR LED

#### 19.PROTECT INDICATOR LED

# NOMENCLATURE AND FUNCTIONS

## 4.2 REAR PANEL

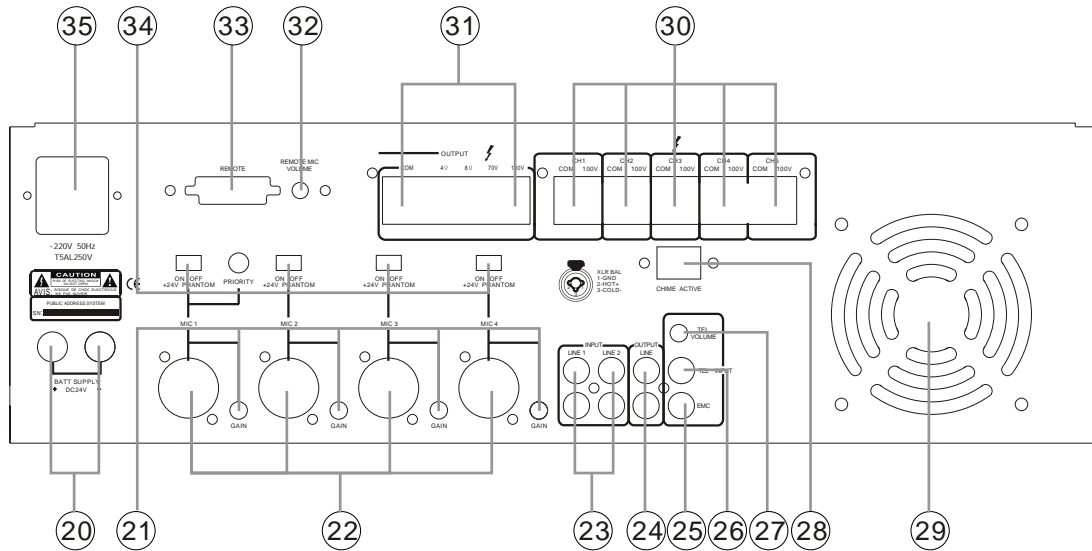

### 20. DC INPUT TERMINALS

These terminals are provided for the connection of backup battery. Connect a 24VDC 50A battery source to these terminals. Make certain the red terminal is connected to the battery's positive (+) side, and the black terminal to the battery's negative (-) side.

### 21.INPUT GAIN CONTROLS(TRIM VR)

These knobs provide continuous control of the input levels for each of the six input channels. When Adjusting the input gain, make certain that the levels are not set too high, or distortion will result.

**NOTE:** It is safe to connect most modern dynamic microphones or line level devices to the channel Inputs when phantom power is activated. However, some older ribbon microphones may be damaged by phantom power, and certain unbalanced line level devices may malfunction or produce an Audible hum when phantom power is active.

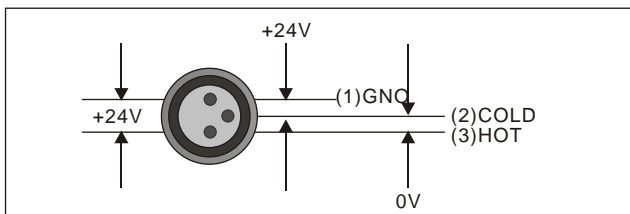

### 22.MIC INPUT CHANNEL 1~4

This is a special connector which will accept either a 3-conductor XLR or a 3-conductor 1/3 jack. These inputs are suitable to receive signal from microphones level devices.

MIC JACK (XLR JACK)	LINE JACK (TRSPHONE JACK)
Pin 1: GROUND	Sleeve: GROUND
Pin 2: HOT(+)	Tip: HOT(+)
Pin 3: COLD(-)	Ring: COLD(-)

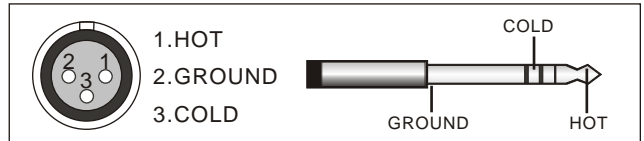

### 23.LINE INPUT CHANNEL 1~2

This line-level input is an extra stereo input for a stereo source such as a tape deck or CD player.

### 24.LINE OUTPUT

(Connection for power amplifier or recording equipment)

### 25.EMC INPUT

When EM switch is connected and pressed in fire or other emergencies, EM broadcasting stored in voice ic is outputted. When selected, these switches will give priority to over all other signals inputs.

### 26.TEL AUDIO INPUT

Remote telephone paging and announcement

### 27.TEL AUDIO VOLUME

### 28.CHIME ACTIVE

Automatic or manual activate chime when paging

### 29.FANNER

### 30.(CH1~CH5)ZONE SPEAKER OUTPUT

### 31.4 Ω、8 Ω、70V、100V SPEAKER OUTPUT TERMINAL

This terminal is for speaker wire connection. connect speakers whose combined impedance is equal to or higher than the rated output impedance, as shown below.

### 32.REMOTE MIC VOLUME

### 33.REMOTE CONTROL INPUT

By connecting a 15-pin D-SUB connector, it is possible to control speaker zone selection and activate the chime via wired remote. connection terminals for the remote are shown below.

Pin 1: Remote amplifier input signal hot(+)	Pin 8: Remote control 5(Speaker 5)
Pin 2: Remote amplifier input signal cold(-)	Pin 9: Remote control ground
Pin 3: Signal ground	Pin 10: DC +24V
Pin 4: Remote control 1(Speaker 1)	Pin 11: Input Chime
Pin 5: Remote control 2(Speaker 2)	Pin 12: NC
Pin 6: Remote control 3(Speaker 3)	Pin 13: NC
Pin 7: Remote control 4(Speaker 4)	Pin 14, 15: NC

### 34.~220V±10%/50HZ POWER INPUT

### 35.MIC 1 PRIORITY SWITCH

When selected, these switches will give priority to Channels 1 over all other channels inputs.

### 36.POWER SWITCH

This switch turns the phantom power supply on or off for all channels. When the switch is turned on, +24V DC power is supplied to pins 2 and 3 of each channel's input connector. Use phantom power when connecting condenser microphones, which require an external power supply.



## 5. OPERATING

### CONNECTING SPEAKERS

Before connecting speakers, disconnect the AC power cable. Note the proper connecting terminals as shown Below. Make certain that the total impedance is not less than the rated impedance indicated.

#### ● CONNECTING HIGH-VOLTAGE DISTRIBUTED SPEAKER SYSTEMS

When connecting speaker system in parallel, you can connect speakers with a total rated input of up to 70W.

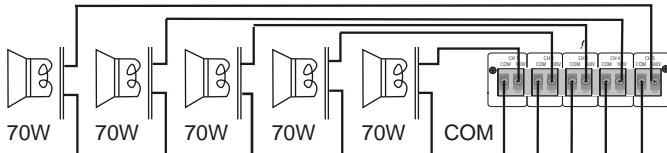

**NOTE:** Be sure that total impedance is not less than rated impedance. (See upper chart.)

**WARNING:** Extreme care must be exercised when connecting high-impedance systems, as Potentially Hazardous voltages may be present at these terminals.

Do not install this equipment in a confined space with less-than-adequate ventilation.

# 6. APPLICATIONS

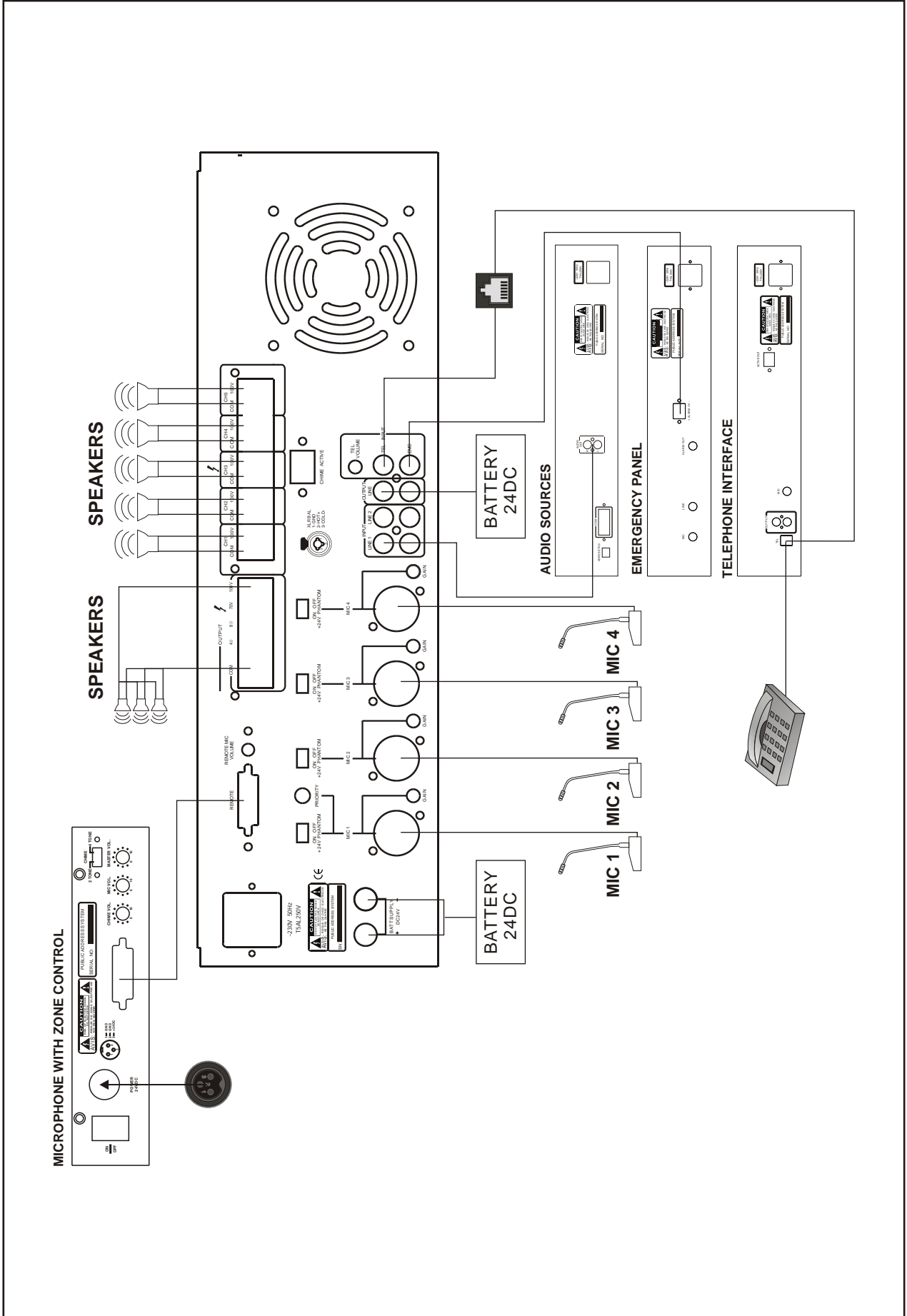

## 7. SPECIFICATIONS

		TI-350S	TI-240S	TI-120S
AMPLIFIER SECTION (4OHMS LOAD OUTPUT)	RATED OUTPUT POWER (THD 1%)	350W(RMS)	240W(RMS)	120W(RMS)
	SPEAKER ZONE 1~5 OUTPUT 25W	70W MAX	50W MAX	20W MAX
MIC INPUT SECTION (MIC 1~4 IN@1KHZ,)	INPUT SENSITIVITY/IMPEDANCE	2.45MV/5K $\Omega$ BAL/245MV/5KohmBAL		
	S/N	Better than 55dB		
	FREQUENCY RESPONSE ( $\pm$ 3DB)	100Hz~15KHz		
	TONE CONTROL (BASS:100HZ, TREBLE:10KHZ)	$\pm$ 12dB		
	PHANTOM POWER	+24VDC		
LINE INPUT SECTION (LINE1~2 IN@1KHZ,)	INPUT SENSITIVITY/IMPEDANCE	250mV/47Kohm		
	S/N	Better than 65dB		
	FREQUENCY RESPONSE ( $\pm$ 3DB)	80Hz~15KHz		
	TONE CONTROL (BASS:100HZ, TREBLE:10KHZ)	$\pm$ 12dB		
TELAUDIO INPUT	INPUT SENSITIVITY/IMPEDANCE	0.3V/10K $\Omega$		
	S/N	Better than 65dB		
	FREQUENCY RESPONSE ( $\pm$ 3DB)	100Hz~15KHz		
PRE AMP OUT(MIC 1~4, LINE 1~2, TEL IN, REMOTE IN)		0dBV/600 $\Omega$		
REMOTE MIC		30mV/600 $\Omega$		
T.H.D		Less than 0.5%		
POWER SOURCE		220- 240VAC; 50/60Hz, 24VDC		
POWER CONSUMPTION		500W	350W	200W
WEIGHT		24.5Kg	20.4Kg	17.1Kg
DIMENSIONS(MM)		482*450*132	482*450*132	482*450*132

# 8. BLOCK DIAGRAM

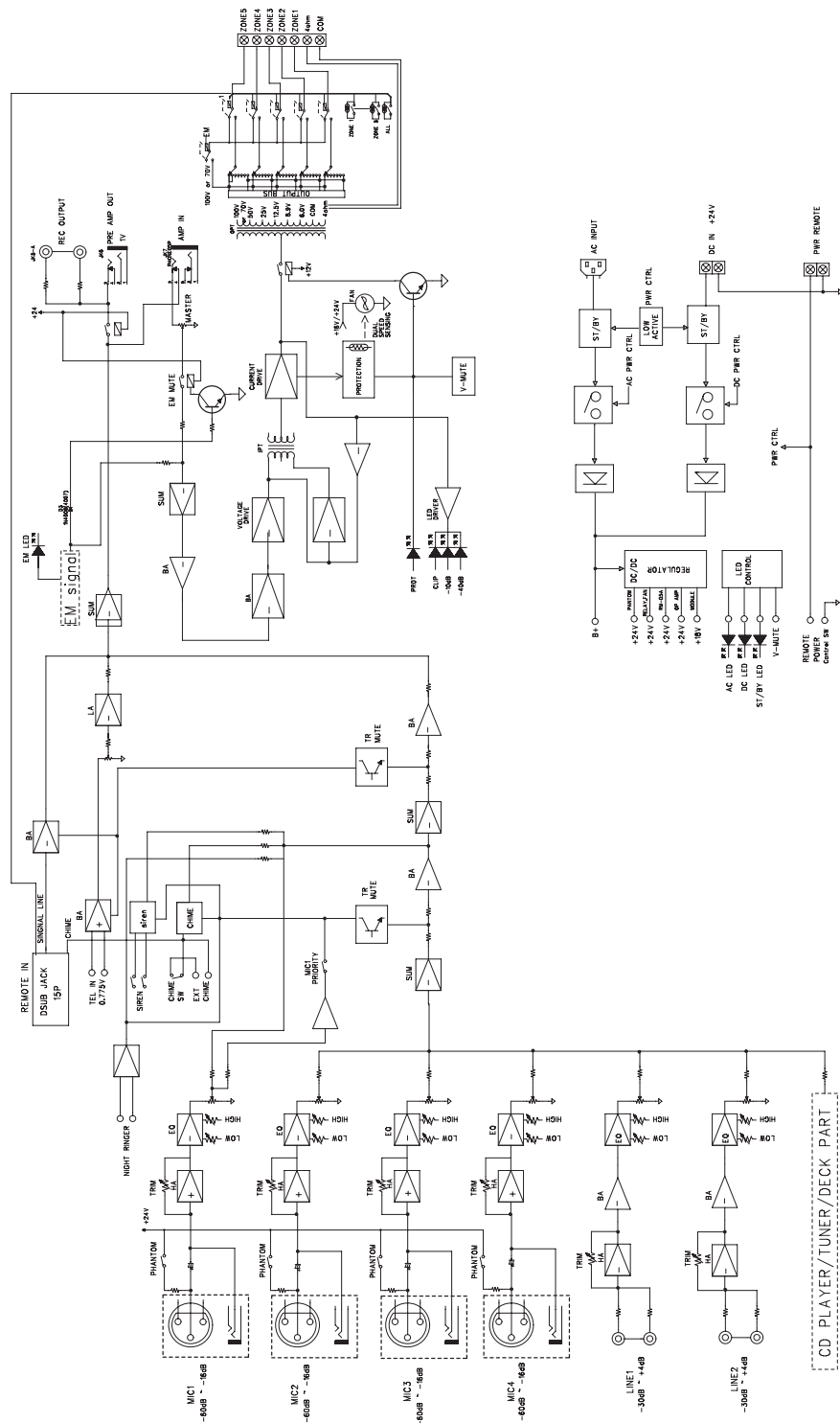

# 9.DIMENSIONAL DIAGRAM

UNIT :mm

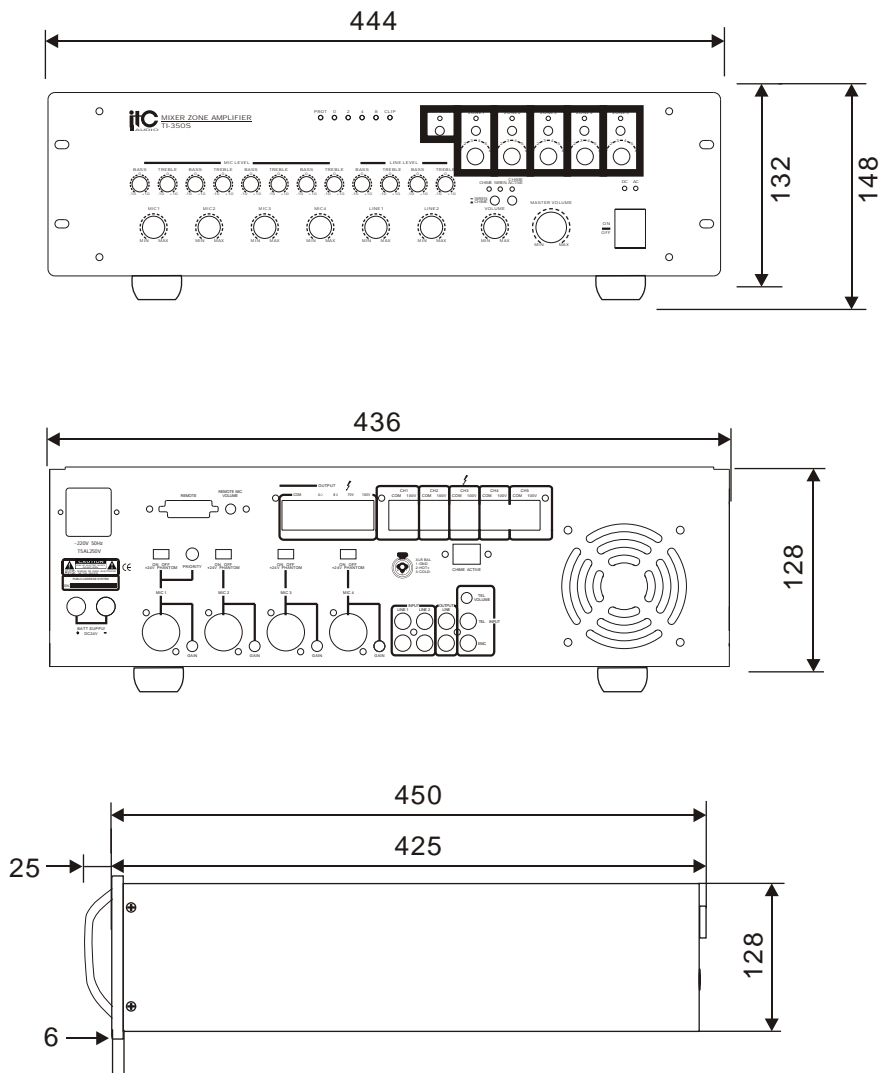

Keep the unit's all sides over 10 cm away from objects that may obstruct air flow to prevent the unit's internal temperature rise.

UNIT :mm

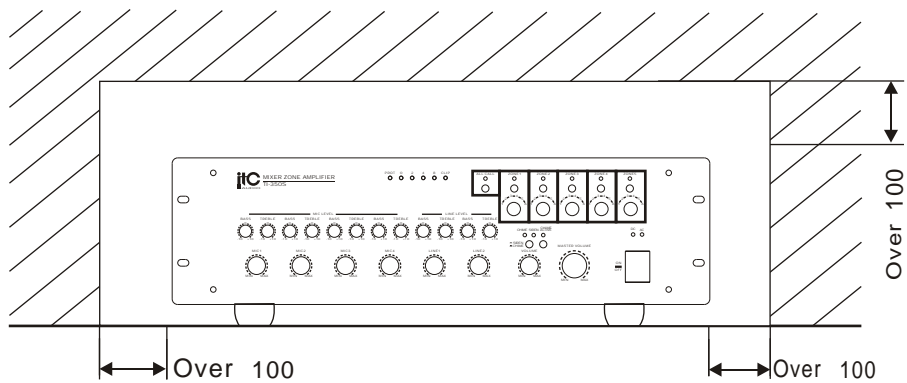

# PUBLIC ADDRESS SYSTEM



Guangzhou ITC Electronic Technology Limited  
[Http://www.itc-pa.com.cn](http://www.itc-pa.com.cn)